







■ **Inductive cylindrical type proximity sensor**

Features

- Reverse power polarity protection.
- Surge protection function.
- Over current protection function.
- Long life cycle and high reliability.
- Able to check the status of operation by Red LED indicator.
- No side sensing.
- Wide range of applications, for replacement of Micro switch, Limit switch.
- Water proof structure by IP 67.

Dimension		Model
Ø3mm		BIT3-PN.8F
		BIT3-NN.8F
Ø4mm		BIT4-PN1F
		BIT4-NN1F
M4		BIR4-PN1F
		BIR4-NN1F

■ **Specifications (DC 3wire type)**

Model	BIT3-PN.8F	BIT3-NN.8F	BIT4-PN1F	BIT4-NN1F	BIR4-PN1F	BIR4-NN1F
Function	PNP Make (NO) 	NPN Make (NO) 	PNP Make (NO) 	NPN Make (NO) 	PNP Make (NO) 	NPN Make (NO) 
Detecting Distance	.8mm		1mm		1mm	
Switching Hysteresis	Max. 15% of Sr					
Standard Detecting Target	3 x 3 x 1mm (Iron)		4 x 4 x 1mm (Iron)		4 x 4 x 1mm (Iron)	
Setting Distance	.8mm ± 10%		1mm ± 10%		1mm ± 10%	
Power Supply (Operating Voltage)	10-30VDC					
Current Consumption	<10mA					
Response Frequency	2 kHz					
Residual Voltage	Max. 1.5V					
Temperature Drift	±10% Max. of detecting distance at +20°C within temperature range of -25 to +70°C					
Control output	150mA					
Connection Type	Cable 2mtr.					
Housing Type	Cylindrical Smooth, 3mm dia, length 25mm		Cylindrical Smooth, 4mm dia, length 25mm		Cylindrical Threaded(.5), 4mm dia, length 25mm	
Housing Material	Cylinder-Stainless Steel, Sensing face-POM					
Vibration & Shock	1mm amplitude at frequency of 10 to 55Hz in each of X, Y, Z directions for 2 hours				500m/s ² (50G) in X, Y, Z direction for 3 times	
Indicator	Operating indicator (RED LED)					
Ambient Temperature	-25 to +70°C (non-freezing condition)					
Storage Temperature	-30 to +80°C (non-freezing condition)					
Ambient Humidity	35 to 95% RH					
Protection Circuit	Surge protection circuit, Overload & short circuit protection					
Protection	IP67					
Weight	Approx. 30g			Approx. 32g		
Approval						

◆ **Dimension Drawings**

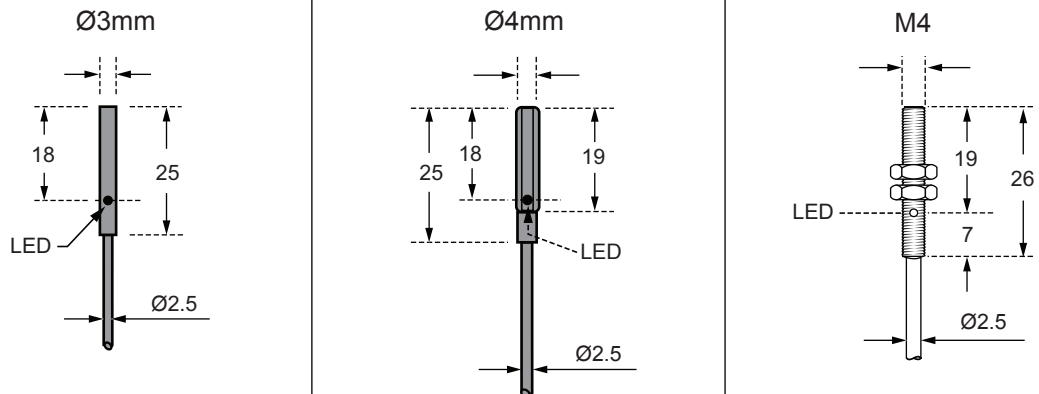

◆ **Connection Diagrams**

